

### XK-120, XK-140, XK-150

- XK-120, with 5-Blade Cast Alloy Fan \_\_\_\_\_ **09-0001**
- XK-120, with 6-Blade Riveted Fan \_\_\_\_\_ **09-0002**
- XK-140, with 8-Blade Fan \_\_\_\_\_ **09-0422**
- XK-150 3.4 to engine V1597 \_\_\_\_\_ **09-0422**
- XK-150 3.4 engines V1598 to V5732 (1/2" wide) **09-0414**
- XK-150 3.4 engine V5733-on \_\_\_\_\_ **09-0174**
- XK-150 3.4 "S" engines VS1001 to VS1522 **09-0414**
- XK-150 3.4 "S" engines VS1523-on (1/2" wide) **09-0174**
- XK-150, all 3.8 engines (1/2" wide) \_\_\_\_\_ **09-0174**

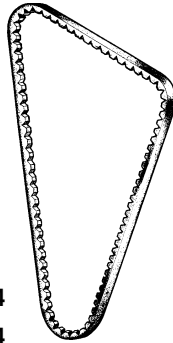

### 420

- Alternator Belt \_\_\_\_\_ **09-0687**
- Water Pump Belt, With Power Steering \_\_\_\_\_ **09-1123**
- Water Pump Belt, Without Power Steering \_\_\_\_\_ **C26890**
- Air Conditioner Belt \_\_\_\_\_ **C25660**

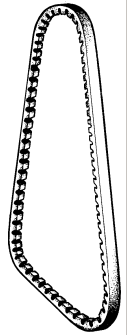

### Series I E-Type

- 3.8 "V" water pump belt, to engine R.5249 **09-15840**
- 3.8 water pump belt, 2-groove, eng. R.5250-on \_\_\_\_\_ **09-0026**
- 4.2 Series I water pump belt \_\_\_\_\_ **09-0117**

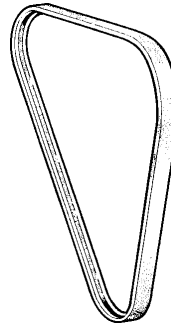

### MK VII, MK VIII, MK IX

- MK VII Fan Belt, (5-Blade Fan) \_\_\_\_\_ **09-0001**
- MK VII Fan Belt, (6-Blade Fan) \_\_\_\_\_ **09-0002**
- MK VII Fan Belt, 3/8" Wide (8-Blade Fan) \_\_\_\_\_ **09-0422**
- MK VIII Fan Belt, to engine N8974 \_\_\_\_\_ **09-0422**
- MK VIII Fan Belt, from engine N8975 \_\_\_\_\_ **09-0414**
- MK IX Fan Belt \_\_\_\_\_ **09-0174**

### Series II E-Type

- Water Pump Belt, Manual Steering Only (C28955) \_\_\_\_\_ **09-0273**
- Water Pump & Power Steering Belt (C31686) \_\_\_\_\_ **09-0091**
- Alternator Belt:**
- W/O Air Conditioning, to SWB 7R.5546 & LWB 7R.37964 \_\_\_\_\_ **09-0638**
- W/O Air Conditioning, 7R.5547 & 7R.37965-on \_\_\_\_\_ **09-0646**
- With "Early" Air Conditioning (45-amp alternator) \_\_\_\_\_ **09-0554**

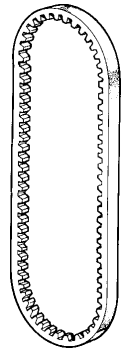

### MK X/420G

- Fan Belt, 3.8 Liter \_\_\_\_\_ **09-0027**
- Water Pump/Power Steering, 4.2 Liter Only \_\_\_\_\_ **09-1123**
- Alternator Belt, 4.2 Liter Only \_\_\_\_\_ **09-0687**

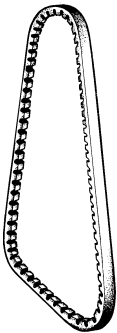

- With "Late" Air Conditioning (60-amp alternator) \_\_\_\_\_ **09-0521**
- A/C Compressor Belt, with "Early" A/C (45-amp alternator) **09-0224**
- A/C Compressor Belt, with "Late" A/C (60-amp alternator) \_\_\_\_\_ **09-0075**
- Note:** "Early" air conditioning was fitted up to FHC & OTS engine number 1R.9456 and 2+2 to engine 1R.42012; "Late" type was fitted thereafter. No "Early" type cars were fitted with power steering.

### MK I 3.4, MK II, 3.4S, 3.8S, 240, 340

- MK I 3.4 Fan Belt, engine KE1001 to KE3887 \_\_\_\_\_ **09-0422**
- MK I 3.4 Fan Belt, engine KE3888 to KE9999 \_\_\_\_\_ **09-0414**
- MK I 3.4 Fan Belt, engine KF1001 to KF2500 \_\_\_\_\_ **09-0414**
- MK II 2.4, engine BH.5365-on, double groove \_\_\_\_\_ **C19523**
- MK II Fan Belt, with 1/2" Wide Belt \_\_\_\_\_ **09-0174**
- MK II Fan Belt, with Double Groove Pulley \_\_\_\_\_ **09-0027**
- 3.4S, 3.8S, 240, 340, Fan Belt \_\_\_\_\_ **09-0027**

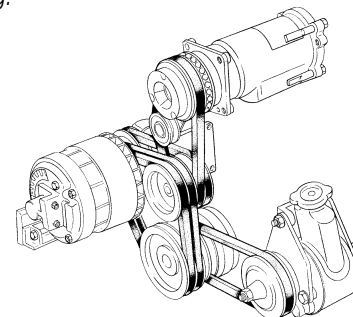
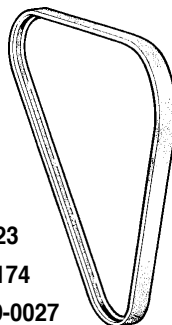

### Series III V-12 E-Type

- Alternator Belt, 2 Required \_\_\_\_\_ **09-1131**
- Power Steering Pump Belt \_\_\_\_\_ **09-0307**
- Air Pump Belt \_\_\_\_\_ **09-0414**
- Air Conditioner Belt \_\_\_\_\_ **09-1059**

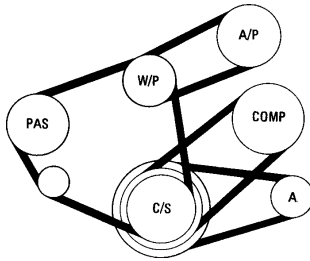

### XJ-6 Series I

Alternator-Crankshaft Belt, to eng. 7L42594	<b>09-1203</b>
Alternator-Crankshaft Belt, from Eng. 7L42595	<b>09-1200</b>
Power Steering Belt	<b>09-1123</b>
Air Conditioner Belt	<b>09-0174</b>

### XJ-6 Series II

Alternator Belt	<b>09-1200</b>
Air Conditioner Belt	<b>09-0174</b>
Power Steering Belt	<b>09-1123</b>
Air Pump Belt	<b>09-1200</b>

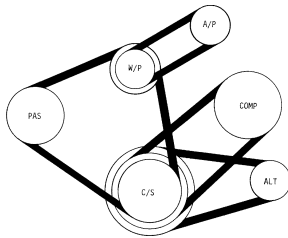

### XJ-6 Series III

Alternator Belt, to VIN 326017 (about 1981.5)	<b>09-0646</b>
Alternator Belt, from VIN 326018	<b>09-0638</b>
Power Steering Belt	<b>09-1123</b>
Air Conditioner Belt	<b>09-0174</b>
Air Pump Belt	<b>09-1200</b>

### XJ-12 Series I & II, 1973-1979

Fan-Crankshaft-Idler Belt	<b>09-1059</b>
Alternator-Crankshaft Belt	<b>09-0646</b>
Power Steering-Crankshaft-Water Pump Belt	<b>09-0208</b>
A/C-Air Pump Belt, carbureted	<b>09-0760</b>
A/C-Air Pump Belt, fuel Injected	<b>09-1236</b>

### XJ-S 5.3 Liter 1976-1993

Alternator-Crankshaft Belt, to Engine No. 8S.57571, (Mid 1988), no ABS, conventional V-belt	<b>09-0646</b>
Alt.-Crank. Belt, 8S.57571 to VIN 185819, serpentine	<b>09-EAC9369</b>
Alt.-Crank. Belt, 5.3 VIN 185820-on	<b>09-NAC2211BA</b>
Power Steering-Water Pump-Crankshaft Belt	<b>09-0208</b>
Air Conditioner-Air Pump Belt	<b>09-1236</b>
Fan-Crankshaft-Idler Belt	<b>09-1059</b>

### XJ-S 4.0 Liter, 1993-1994

Alternator Drive Belt, to VIN 185819	<b>09-EAC7033</b>
Alternator Drive Belt, VIN 185820-on	<b>09-EBC11306</b>
Air Conditioning Compressor Belt	<b>09-EAC3878</b>
Air Pump Belt (introduced at VIN 185820)	<b>09-EAC6335</b>

### XJ-S 6.0 Liter, 1994-on

A/C to Air Pump to Crankshaft Belt	<b>09-NAB4705AA</b>
Water Pump to Power Steering to Crank Belt	<b>09-0208</b>
Fan to Crankshaft Belt	<b>09-1059</b>
Alternator Belt	<b>09-NAC2211BA</b>

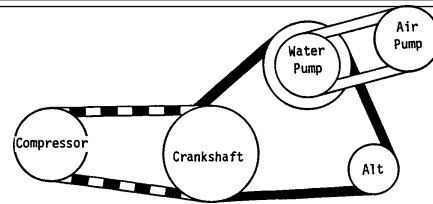

### XJ-40 3.6 & 4.0, 1988-1994

W/P & Alt., 80 Amp, to engine 109969, 1988 to VIN507393	<b>09-EAC3850</b>
W/P & Alt., 90 Amp, eng. 109970, Vin 507394 Thru 1992	<b>09-EAC7033</b>
W/P & Alt., 1993-on	<b>09-EBC11306</b>
Air Pump Belt, all XJ-40	<b>09-EAC6335</b>
Air Conditioner Compressor Belt, all XJ-40	<b>09-EAC3878</b>

### XJ-12 (XJ-40 Series) 1994

Power Steering & Air Conditioning	<b>09-EBC1500</b>
Water Pump & Air Pump	<b>09-EAC9898</b>
Alternator	<b>09-NAC2211BA</b>

### XJ-6 (X300 Series) 1995-1997

Alternator Belt, not supercharged	<b>09-EBC11306</b>
Alternator Belt, supercharged	<b>09-NBD3700BA</b>
Air Conditioner Compressor Belt, all	<b>09-EBC11220</b>
Supercharger Drive Belt, XJ-R	<b>09-NBD7740EA</b>

### XJ-12 ("X300" Series) 1995-1997

A/C Compressor & Power Steering	<b>09-NNA4705AA</b>
Water Pump & Air Pump	<b>09-EAC9898</b>
Alternator	<b>09-NAC2211BA</b>

### XK8 & XKR

Serpentine Belt, Supercharged, through 1999	<b>09-NCA2211DA</b>
Serpentine Belt, Non-Supercharged, through 1999	<b>09-NCA2211AC</b>
Serpentine Belt, all, 2000-2002	<b>09-NCA2211DA</b>
Serpentine Belt, all, 2003-on	<b>JA-AJ8-9191</b>
Supercharger Belt, through 1999	<b>09-NCC7740AD</b>
Supercharger Belt, 2000-2002	<b>09-NCC7740BA</b>
Supercharger Belt, 2003-on	<b>JA-C2C-26235</b>

### XJ-8/XJR V-8

Engine Drive Belt, Non-Supercharged	<b>09-NCA2211AC</b>
Engine Drive Belt, Supercharged (XJR)	<b>09-NCA2211CA</b>
Supercharger Drive Belt, through 1999	<b>09-NCC7740AD</b>
Supercharger Drive Belt, 2000-2003	<b>09-NCC7740BA</b>
Serpentine Belt, 2004-on	<b>JA-AJ8-9191</b>
Supercharger Drive Belt, 2004-on	<b>JA-C2C-26235</b>

### New S-Type, 2000-on

#### V-6

Serpentine Engine Drive Belt, to M45254	<b>JA-AJ8-4136</b>
Serpentine Engine Drive Belt, M45255 to M62935	<b>JA-C2S-5231</b>
Serpentine Engine Drive Belt, M62936 to N13088	<b>JA-AJ8-5631</b>
Serpentine Engine Drive Belt, N13089-on	<b>JA-AJ8-9034</b>

#### V-8

Serpentine Engine Drive Belt, to M45254	<b>JA-XR8-30447</b>
Serpentine Engine Drive Belt, M45255-on	<b>JA-AJ8-9191</b>
Supercharger Drive Belt	<b>JA-C2C-26235</b>

### X-Type

Serpentine Engine Drive Belt	<b>JA-C2S-24900</b>
Water Pump Belt	<b>JA-AJ8-4229</b>